



# HC 1217W

## 12V 17W

HC 1217W is specially designed for high efficient discharge application. Its invisible terminal can be inserted PC board directly. HC series battery can serve more than 260 cycles at 100% discharge in cycle service, or three to five years in standby service.



### Specification

<b>Cells Per Unit</b>	6
<b>Voltage Per Unit</b>	12
<b>Capacity</b>	17W @ 15minute-rate to 1.67V per cell @25 °C (77°F)
<b>Weight</b>	Approx. 1.64kg(3.6 lbs)
<b>Maximum Discharge Current</b>	60A(5sec)
<b>Internal Resistance</b>	Approx. 42mΩ
<b>Operating Temperature Range</b>	Discharge: -20°C~50°C (-4°F~122°F) Charge: 0°C~40°C (32°F~104°F) Storage: -20°C~40°C (-4°F~104°F)
<b>Nominal Operating Temperature Range</b>	25°C±3°C (77°F±5°F)
<b>Float Charging Voltage</b>	13.5 to 13.8 VDC/unit Average at 25°C (77°F)
<b>Recommended Maximum Charging Current Limit</b>	1.7A
<b>Equalization and Cycle Service</b>	14.4 to 15.0 VDC/unit Average at 25°C (77°F)
<b>Self Discharge</b>	CSB Batteries can be stored for more than 6 months at 25°C (77°F). Please charge batteries before using. For higher temperatures the time interval will be shorter.
<b>Terminal</b>	Faston Tab 187/250
<b>Container Material</b>	-ABS (UL94-HB)*Flammability resistance of UL94-V2 can be available upon request.



CSB-manufactured batteries are UL-recognized components under UL924 as well as ISO 9001 and ISO 14001 certified.

### Dimensions

unit: (MM)

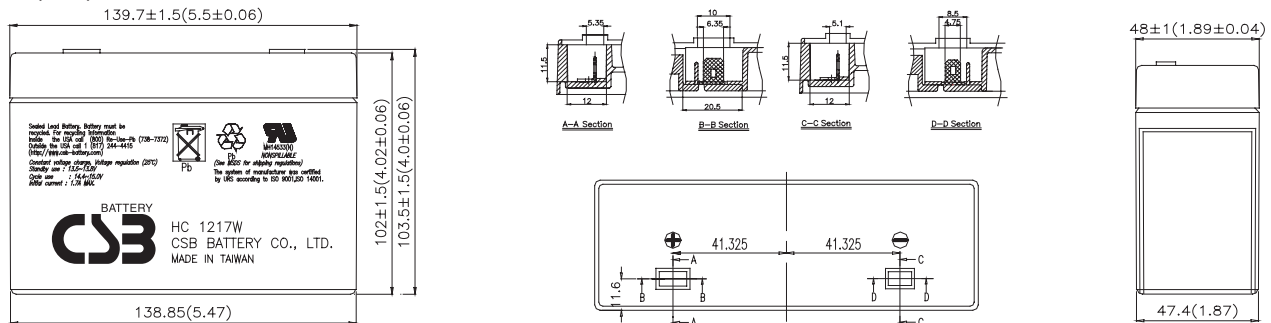

### Constant Current Discharge Characteristics Unit:A (25°C, 77°F)

F.V/Time	2MIN	4MIN	6MIN	8MIN	10MIN	15MIN	20MIN	30MIN	60MIN	90MIN
1.60V	29.83	21.58	18.50	15.08	12.67	9.33	8.26	6.13	3.44	2.11
1.67V	26.45	20.53	17.33	14.67	12.38	9.16	8.08	6.03	3.38	2.07
1.70V	25.00	20.08	16.83	14.50	12.25	9.08	8.00	5.98	3.35	2.05
1.75V	23.38	18.58	15.54	13.63	11.88	8.75	7.75	5.86	3.28	1.97
1.80V	21.75	17.08	14.25	12.75	11.50	8.42	7.50	5.73	3.21	1.88
1.85V	20.13	15.58	12.96	11.88	11.13	8.09	7.25	5.61	3.14	1.80

### Constant Power Discharge Characteristics Unit:W (25°C, 77°F)

F.V/Time	2MIN	4MIN	6MIN	8MIN	10MIN	15MIN	20MIN	30MIN	60MIN	90MIN
1.60V	358.00	259.00	222.00	181.00	152.00	112.00	99.10	73.50	41.30	25.30
1.67V	317.40	246.40	208.00	176.10	148.50	109.90	96.93	72.31	40.53	24.81
1.70V	300.00	241.00	202.00	174.00	147.00	109.00	96.00	71.80	40.20	24.60
1.75V	280.50	223.00	186.50	163.50	142.50	105.00	93.00	70.25	39.35	23.55
1.80V	261.00	205.00	171.00	153.00	138.00	101.00	90.00	68.70	38.50	22.50
1.85V	241.50	187.00	155.50	142.50	133.50	97.00	87.00	67.15	37.65	21.45

- All mentioned values are average values.
- Low rate discharge mode (over 90 mins.) is not recommended.

## Trickle (or Float) Service Life

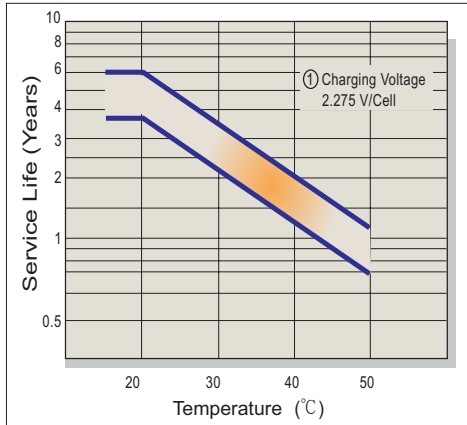

## Capacity Retention Characteristic

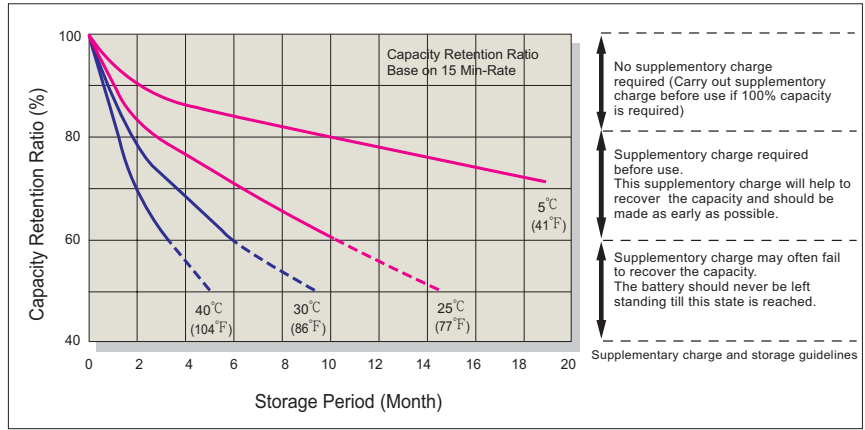

## Battery Voltage and Charge Time for Standby Use

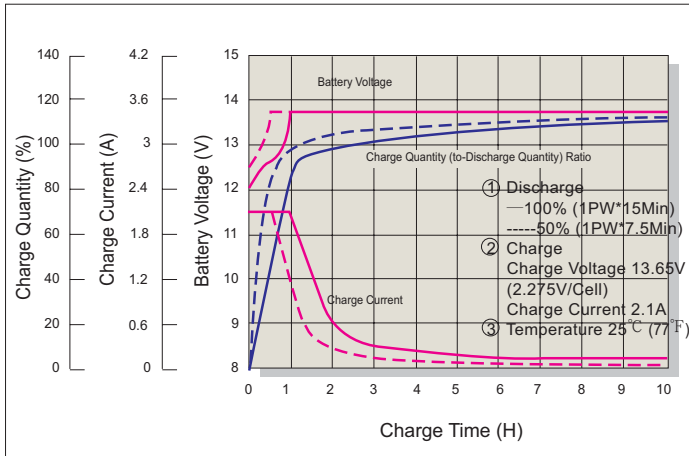

## Cycle Service Life

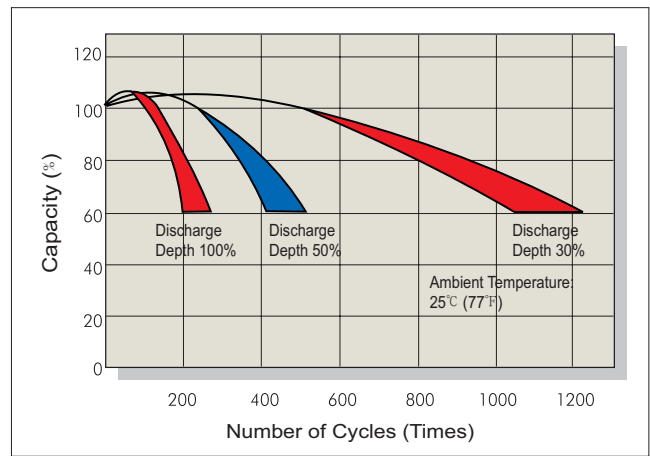

## Battery Voltage and Charge Time for Cycle Use

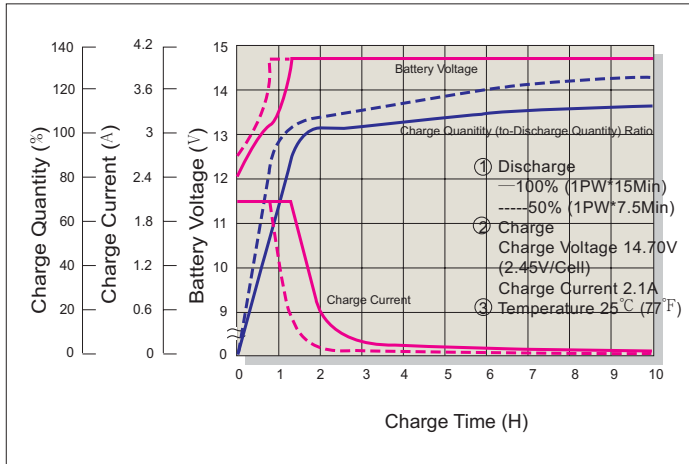

## Terminal Voltage (V) and Discharge Time (25°C 77°F)

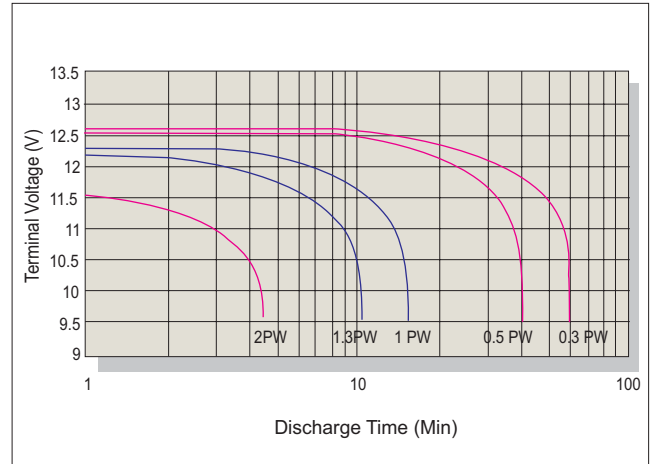

## Charging Procedures

Application	Charge Voltage (V/Cell)			Max. Charge Current
	Temperature	Set Point	Allowable Range	
Cycle Use	25°C (77°F)	2.45	2.40-2.50	0.3C
Standby	25°C (77°F)	2.275	2.25-2.30	

## Discharge Current VS. Discharge Voltage

Final Discharge Voltage V/Cell	1.75	1.70	1.55	1.30
Discharge Current (A)	0.2C>(A)	0.2C<(A)<0.5C	0.5C<(A)<1.0C	(A)>1.0C

Sales Office URL: [WWW.CSB-BATTERY.COM](http://WWW.CSB-BATTERY.COM)

### CSB BATTERY CO., LTD.

**TAIWAN OFFICE**  
Tel: +886-2-8751-5000  
Fax: +886-2-8751-6161  
E-mail: [service@csb-battery.com.tw](mailto:service@csb-battery.com.tw)

### CSB BATTERY OF NETHERLANDS B.V

**NETHERLANDS OFFICE**  
Tel: +31(0) 180 418 140  
Fax: +31(0) 180 418 327  
E-mail: [eurosales@csb-battery.com](mailto:eurosales@csb-battery.com)

### CSB BATTERY (SINGAPORE) PTE., LTD.

**SINGAPORE OFFICE**  
Tel: +65-6742-4944  
Fax: +65-6742-4744  
E-mail: [sales@csb-battery.com.sg](mailto:sales@csb-battery.com.sg)

### CSB BATTERY TECHNOLOGIES, INC.

**USA OFFICE**  
Tel: +1-817-244-7777/1-8003 CSBUSA(272872)  
Fax: +1-817-244-4445  
E-mail: [csb@csb-battery.com](mailto:csb@csb-battery.com)

### CSB BATTERY LOGISTICS (SHANGHAI) CO., LTD.

**SHANGHAI OFFICE**  
Tel: +86-21-5046-1622, 5046-0833  
Fax: +86-21-5064-3314

### CSB BATTERY LOGISTICS (SHANGHAI) CO., LTD.

**BEIJING OFFICE**  
Tel: +86-10-6597-8060, 6597-8070  
Fax: +86-10-6597-8050  
E-mail: [chinasls@csb-battery.com](mailto:chinasls@csb-battery.com)