

FEATURES/ BENEFITS

- Size: 3.15 in sq. X .98 in (80.0mm sq. X 25.0 mm)
- Airflow: 25-46 CFM
- Weight: 3.3oz (95g)
- Noise: 22-40 dBA
- Lead Wire:
 - AWG 24, Red/Black, UL1007, CSA TR-64
 - AWG 26, Red/Black/White, for 3 lead wires
- Impeller and Venturi: UL94V-0 Reinforced polybutylene plastic

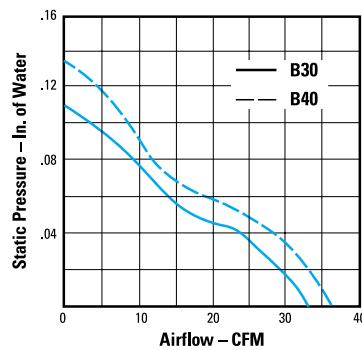

DC 3110KL Brushless Fan

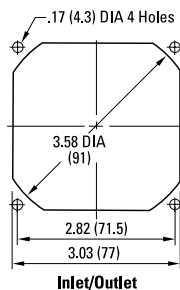
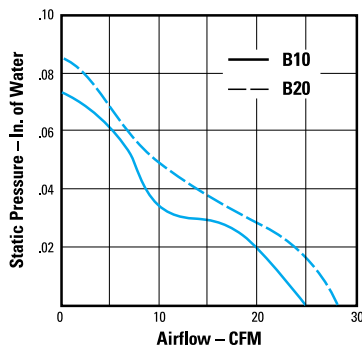
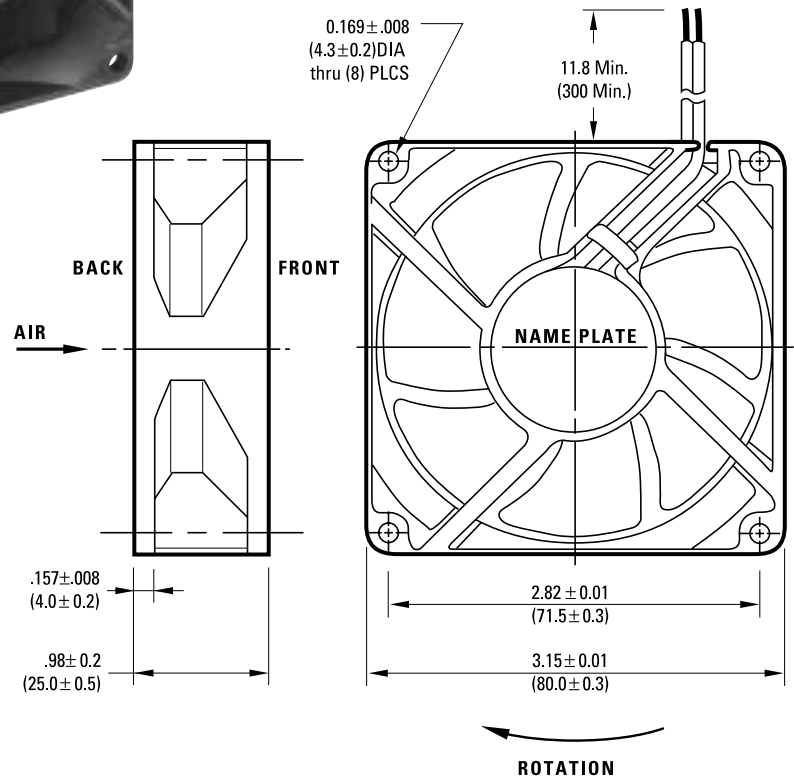

RIB TYPE (L00)

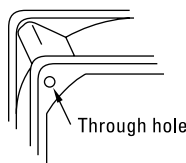

FLANGE TYPE (P00)

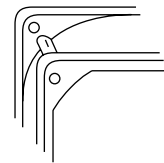

Dimensions are in inches () are in millimeters

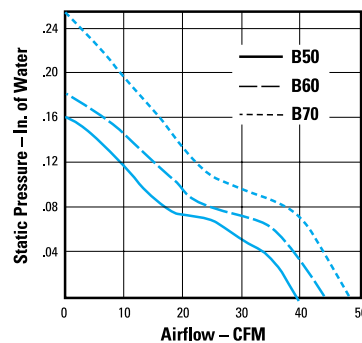

MODEL NUMBER	VOLTAGE (V)	POWER (W)	CURRENT (A)	SPEED (RPM)	NOISE (dBA)	PRESSURE (in H2O)	AIRFLOW (CFM)
3110KL-04W-B10-P00	12	1.20	100	2150	22	0.06	25
B20-P00	12	1.32	110	2400	25	0.08	28
B30-P00	12	2.04	170	2700	28	0.10	32
B40-P00	12	2.40	200	3000	31	0.13	35
B50-P00	12	2.76	230	3250	34	0.15	39
B60-PA0	12	3.12	260	3600	36.5	0.18	44
B70-P00	12	3.36	290	4000	40	0.26	46
3110KL-05W-B10-P00	24	1.44	60	2150	22	0.06	25
B20-P00	24	1.68	70	2400	25	0.08	28
B30-P00	24	1.92	80	2700	28	0.10	32
B40-P00	24	2.40	100	3000	31	0.13	35
B50-P00	24	2.88	120	3250	34	0.15	39
B60-PA0	24	3.36	140	3400	35	0.16	40